

Ultra-stable, high precision (ppm class) fluxgate technology DN Series current transducer for non-intrusive, isolated DC and AC current measurement up to 1500 A



Features

- Ø41mm aperture
- 1 ppm linearity
- 5 ppm offset
- Compact aluminium housing
- Current output
- High stability closed loop fluxgate technology

Applications

- Electric vehicle (EV) test bench
- Power measurement and power analysis
- MPS for particles accelerators
- Gradient amplifiers for MRI devices
- Batteries testing and evaluation systems
- Current calibration purposes

Electrical specifications at 23 °C, ± 15 V supply voltage

Parameter	Symbol	Unit	Min	Typ.	Max	Comment
Nominal primary AC current	$I_{PN\ AC}$	Arms			1000	See Fig. 3 & Fig. 4 for details
Nominal primary DC current	$I_{PN\ DC}$	A	-1000		1000	For other values see Fig. 2
Measuring range	\hat{I}_{PM}	A	-1500		1500	See Fig. 2 & Fig. 4 for details
Overload capacity	\hat{I}_{OL}	A			5000	Non-measured 100ms
Short term overrange	<30 minutes	Arms			1200	$U_c = \pm 15V, R_M = 1\ \Omega, T_a = 35^\circ C$
Nominal secondary current	I_{SN}	mA	-666.67		666.67	At nominal primary DC current
Primary / secondary ratio				1500		$I_{primary}/I_{secondary}$
Measuring resistance	R_M	Ω	0	1.5		See Fig. 2 and Fig. 3 for details
Linearity error	ϵ_L	ppm	-1	± 0.3	1	ppm refers to $I_{PN\ DC}$
Offset current (including earth field)	I_{OE}	ppm	-5	1	5	ppm refers to $I_{PN\ DC}$
Offset temperature coefficient	TC_{IOE}	ppm/K	-0.1	± 0.02	0.1	ppm refers to $I_{PN\ DC}$
Offset stability over time		ppm/month	-0.1		0.1	ppm refers to $I_{PN\ DC}$
Bandwidth	$f(\pm 3dB)$	kHz		400		Small signal. See Fig. 5
Response time to a step current I_{PN}	t_r	μs		1		To 90% of step current
Total accuracy	ϵ_{tot}		% of reading + % of full scale			Without offset.
<10 Hz			0.0001 + 0.0001			Full scale refers to $I_{PN\ DC}$.
<100 Hz			0.0002 + 0.0002			For details, see Reading and full scale
<1 kHz			0.01 + 0.0003			For other frequencies, see Linear interpolation of accuracy specification .
<10 kHz			0.15 + 0.0004			
<100 kHz			5 + 0.0015			
<400 kHz			30 + 0.003			
Phase shift						
<10 Hz				0.01°		
<100 Hz				0.01°		
<1 kHz				0.02°		
<10 kHz				0.2°		
<100 kHz				3°		
<400 kHz				45°		
RMS noise		ppm rms				ppm refers to $I_{PN\ DC}$
<10 Hz				0.2	0.4	
<100 Hz				0.2	0.4	
<1 kHz				0.2	0.4	
<10 kHz				0.2	0.4	
<100 kHz				1.5	4	
Peak-to-peak noise		ppm p-p				ppm refers to $I_{PN\ DC}$
<10 Hz				0.2	0.6	
<100 Hz				0.5	1	
<1 kHz				0.6	1	
<10 kHz				1.4	4	
<100 kHz				4	10	
Fluxgate excitation frequency	f_{exc}	kHz		31.25		
Power supply voltages	U_c	V	± 14.25		± 15.75	
Idle current consumption		mA		± 81		Primary current = 0 A
Current consumption at max current		A	-1.1		1.1	At \hat{I}_{PM}
Power consumption		W			18.5	At \hat{I}_{PM}
Operating temperature range	T_a	°C	-40		85	
Offset change with external magnetic field		ppm/mT	-4	± 2	4	ppm refers to nominal current
Offset change with power supply voltage changes		ppm/V	-0.2	± 0.05	0.2	ppm refers to nominal current

Linearity error

Linearity error is defined as the deviation from a straight line. The straight line is a linear regression trend line based on the least squares method of the measurement points from 0 to positive max current and another trendline is calculated from 0 to negative max current. The difference between each measured point and the linear trend line is the linearity error. The linearity error ϵ_L can be expressed as (1), where I_{reading} is the measurement result and I_{fitted} is the regression value.

$$\epsilon_L = I_{\text{reading}} - I_{\text{fitted}} \quad (1)$$

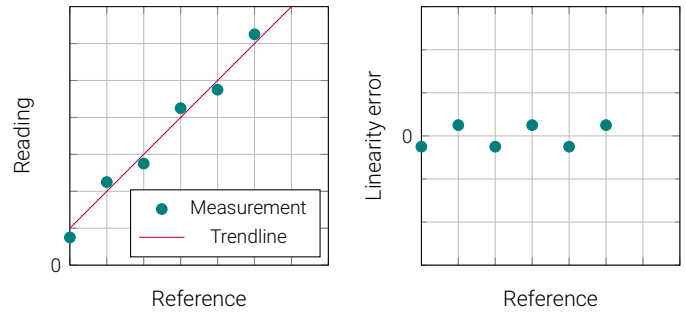

Figure 1: Linearity error definition

Reading and full scale

Reading is the actual value measured at a given time. Full scale is the rated nominal value of the device. If a given current I_{reading} is measured, the total accuracy is calculated as (2). Example: A 500 A rated device has a specification of 0.005% + 0.0015% (reading + full scale) at < 10 Hz. The device is measuring (reading) 10 A dc, and the accuracy is calculated as (3).

$$\epsilon_{\text{tot}} = \epsilon_{\text{reading}} \cdot I_{\text{reading}} + \epsilon_{\text{fullscale}} \cdot I_{\text{PNDC}} \quad (2)$$

$$\epsilon_{\text{tot}} = 0.005\% \cdot 10\text{A} + 0.0015\% \cdot 500\text{A} = 8\text{mA} \quad (3)$$

Primary and secondary current/voltage

The secondary current I_S or voltage V_S is calculated by using the transfer ratio k , as in (4).

$$I_S = \frac{I_P}{k}, \quad V_S = \frac{V_P}{k} \quad (4)$$

Converting from ppm of nominal to secondary current/voltage

The nominal primary current is the rated current for the device. If ϵ_{ppm} is the error in ppm referred to nominal, use (5) to convert to ampere primary current. If the primary/secondary transfer ratio is k , use (6) to convert to ampere secondary current. If the device has voltage output, use (7)

$$\epsilon_{\text{Pampere}} = \epsilon_{\text{ppm}} \cdot I_{\text{PNDC}} \cdot 1 \times 10^{-6} \quad (5)$$

$$\epsilon_{\text{Sampere}} = \epsilon_{\text{ppm}} \cdot \frac{I_{\text{PNDC}}}{k} \cdot 1 \times 10^{-6} \quad (6)$$

$$\epsilon_{\text{Svoltage}} = \epsilon_{\text{ppm}} \cdot \frac{V_{\text{PNDC}}}{k} \cdot 1 \times 10^{-6} \quad (7)$$

Linear interpolation of accuracy specification

If the accuracy at a specific frequency is required, it is possible to use linear interpolation between known points. If the frequency f is $f_1 < f < f_2$ and the accuracy at the frequency $\epsilon(f)$ is $\epsilon(f_1) < \epsilon(f) < \epsilon(f_2)$, then the accuracy at f is found as (8).

$$\epsilon(f) = \frac{f_2 - f_1}{\epsilon(f_2) - \epsilon(f_1)}(f - f_1) + \epsilon(f_1) \quad (8)$$

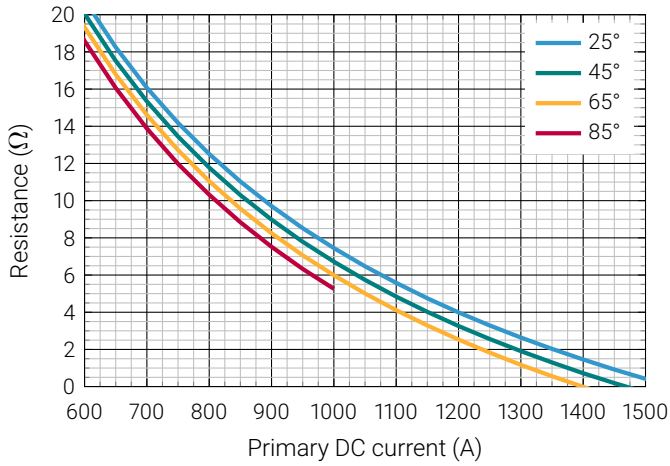

Figure 2: Maximum measurement resistor vs. ambient temperatures

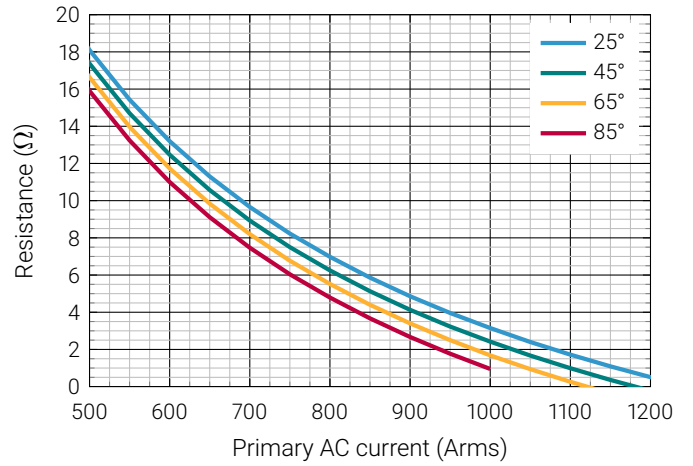

Figure 3: Maximum measurement resistor vs. ambient temperatures

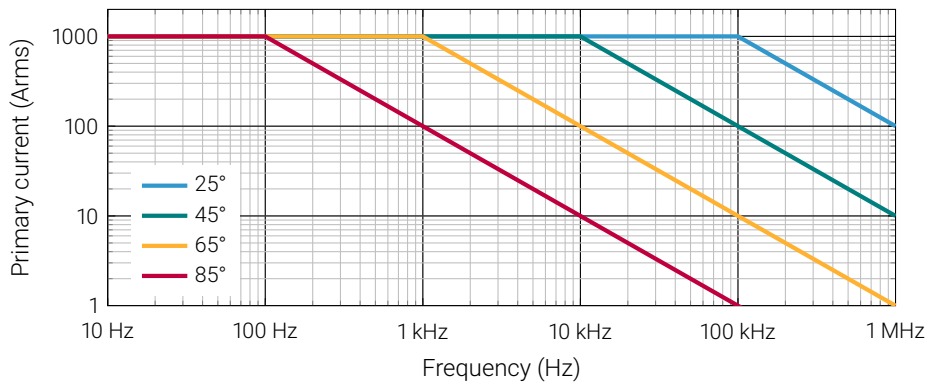

Figure 4: Maximum continuous primary current vs. frequency

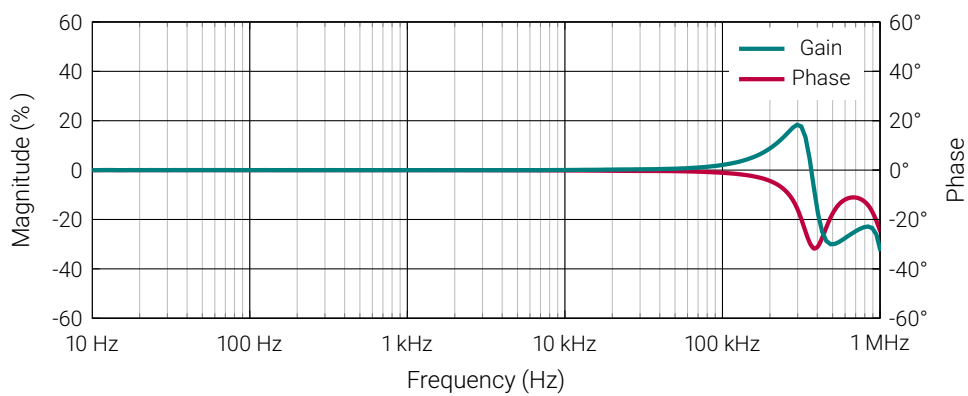

Figure 5: Frequency characteristics

Isolation specifications according to IEC 61010-1



When using *REINFORCED insulated* wire, all wiring must be insulated for the highest voltage used. When using *BASIC insulated* or *uninsulated* wire, follow the specified voltages in the table below:

Parameter	Unit	Value
Clearance	mm	11
Creepage distance	mm	11
Comparative tracking index (CTI)	V	> 600
Continuous working voltage according to IEC 61010-1 with:		
<i>Uninsulated</i> wire:		
Non mains		1000
CAT II (dc and rms)		1000
CAT III (dc and rms)	V	600
<i>BASIC insulated</i> wire:		
Non mains		2000
CAT II (dc and rms)		1000
CAT III (dc and rms)		1000
Transient voltage according to IEC 61010-1 with:		
<i>Uninsulated</i> wire:		
Non mains		5000
CAT II		9500
CAT III		9500
<i>BASIC insulated</i> wire:		
Non mains	V	7500
CAT II		6000
CAT III		8000



Do not connect the transducer to signals or use for measurements within Measurement Category IV, or for measurements on MAINS circuits or on circuits derived from Overvoltage Category IV which may have transient overvoltages above what the product can withstand. The product must not be connected to circuits that have a maximum voltage above the continuous working voltage, relative to earth or to other channels, or this could damage and defeat the insulation.

Environmental and mechanical characteristics

Parameter	Unit	Min	Typ	Max	Comment
Altitude	m			2000	
Usage					Designed for indoor use
Pollution degree				2	
Operating temperature range	°C	-40		85	
Storage temperature range	°C	-40		85	
Relative humidity	%	20		80	Non-condensing
Mass	kg		0.75		

Connections: DSUB-9

Standards: EMC: EN 61326-1:2013-2021

Safety: IEC 61010-2-030:2021/A11:2021 and IEC 61010-1:2010/A1:2019

External devices: External devices connected to current transducers must comply with the standards IEC61010-1 and IEC62368-1 and be energy-limited circuitry

Cleaning:	The transducer should only be cleaned with a damp cloth. No detergent or chemicals should be used.
Temperature:	When multiple primary turns are used or high primary currents are applied the temperature around the transducer will increase, please monitor to ensure that the maximum ratings are not exceeded. It is recommended to have minimum 1 mm ² per ampere in the primary bus bar.

Removable isolation plastic insert



If the isolation plastic insert is removed to increase aperture diameter, the user must ensure proper electrical insulation of the busbar according to IEC 61010-1 to meet the safety requirements to avoid electric shock.

Intended use

The DN1000ID is designed to measure current up to 1500 A, and be powered by a DSSIU-4-1U or DSSIU-6-1U.

Please see the product manual: <https://danisense.com/wp-content/uploads/2021/11/DS-Product-Manual-v1-2.pdf>

Instruction for use

1. Do not power up the device before all cables are connected.
2. Place the primary conductor through the aperture of the transducer.
3. Connect a DSUB cable between DSSIU-4(6)-1U and each sensor.
4. Connect a low impedance amperemeter, measuring resistor or power analyzer on the secondary output (4mm red and black connectors).
5. Ensure that no calibration connectors are attached when measuring primary current. Always avoid to create a calibration short circuit, between + and – calibration connection.
6. There is a risk of electrical shock if an uninsulated busbar with high voltages is touching the metal enclosure of the transducer. Please ensure before powering up the system that no primary busbar can touch the metal enclosure.
7. When all connection are secured - connect mains power.
8. Apply primary current.

Advanced Sensor Protection Circuits "ASPC"

Developed to protect the current transducer from typical fault conditions:

- Unit is un-powered and secondary circuit is open or closed
- Unit is powered and secondary circuit is open or interrupted

Both DC and AC primary current up to 100% of nominal value can be applied to the current transducers in the above situations without damage to the electronics. Please notice that the transducer core can be magnetized in all above cases, leading to a small change in output offset current (less than 10ppm)



Do not disassemble the unit. If the green status LED is not operating with all cables connected and the system powered up, disconnect power and contact Danisense for further instruction. If the equipment is used in a manner not specified by the manufacturer, the protection provided by the equipment may be impaired.

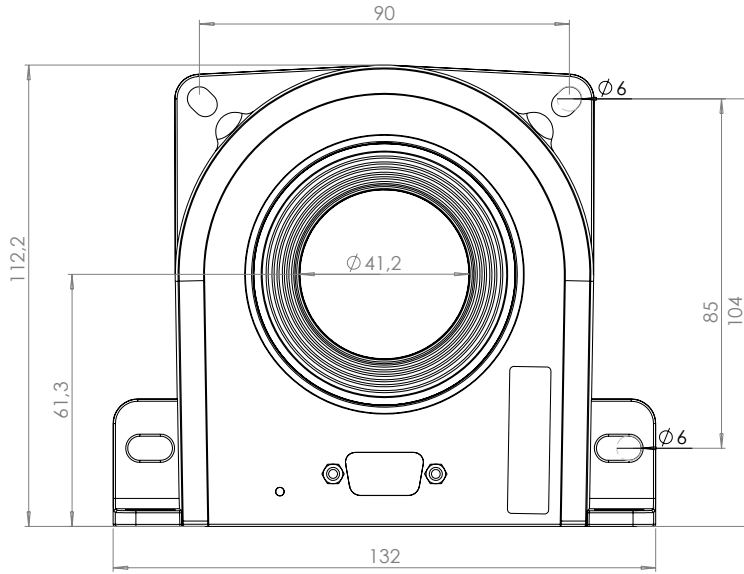

Figure 6: Dimensions of transducer. 0.3 mm Tolerance

Mounting

- Base plate mounting: 2 slotted holes $\varnothing 6$ mm
- Back plate mounting: 4 slotted holes $\varnothing 6$ mm
- Fastening torque: 5.5 Nm

Positive current direction

Is identified by an arrow on the back side isolation plastic insert.

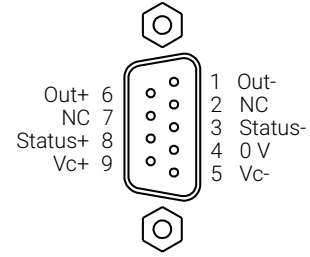

Figure 7: DSUB-9 connection pinout

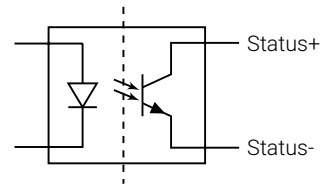

Figure 8: Status signal optocoupler

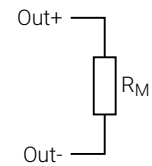
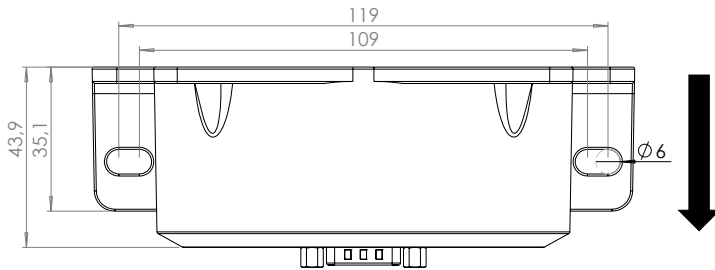

Figure 9: External measurement resistor connection

Status signal

When the sensor is operating in normal condition the status pins (Status+ and Status-) are shorted by an optocoupler, see Fig. 8.

- Forward direction: Pin 8 to pin 3
- Maximum forward current: 10 mA
- Maximum forward voltage: 60 V
- Maximum reverse voltage: 5 V

Declaration of Conformity

Danisense A/S
Malervej 10
DK-2630 Taastrup
Denmark

Declares that under our sole responsibility that this product is in conformity with the provisions of the following EC Directives, including all amendments, and with national legislation implementing these directives:

Directive 2014/30/EU

Directive 2014/35/EU

And that the following harmonized standards have been applied

EEN 61010-1 (Third Edition):2010, EN 61010-1:2010/A1:2019

EN 61010-2-030:2021/A11:2021

EN 61326-1:2013

All DANISENSE products are manufactured in accordance with RoHS directive 2011/65/EU. Annex II of the RoHS directive was amended by directive 2015/863 in force since 2015, expanding the list of 6 restricted substances (Lead, Hexavalent Chromium, PBB, PBDE and Cadmium)

Danisense follows the provision in EN 63000:2018



Place
Taastrup, Denmark

Henrik Elbæk

Date
2022-03-15