

Ultra-stable, high precision (ppm class) fluxgate technology DS Series current transducer for non-intrusive, isolated DC and AC current measurement up to 3000A



Features

- 1 ppm linearity
- 6 ppm offset
- Current output
- Fluxgate, closed loop compensated technology with fixed excitation frequency and second harmonic zero flux detection for best in class accuracy and stability
- 100 turns calibration winding available in BNC connector - For ±50A test and calibration in circuit.
- Green diode for normal operation indication
- Full aluminum body for superior EMI shielding and extended operating temperature range
- Large aperture φ68mm for cables and bus bars

Applications:

- MPS for particles accelerators
- Gradient amplifiers for MRI devices
- Stable power supplies
- Precision drives
- Batteries testing and evaluation systems
- Power measurement and power analysis
- Current calibration purposes

Specification highlights	Symbol	Unit	Min	Typ	Max
Nominal primary AC current	$I_{PN AC}$	Arms			2000
Nominal primary DC current	$I_{PN DC}$	A	-3000		3000
Measuring range	\hat{I}_{PM}	A	-3000		3000
Primary / secondary ratio	$n1 : n2$		1:1500		1:1500
Linearity error	$?_L$	ppm	-1		1
Offset current (including earth field)	I_{OE}	ppm	-6		6
DC-10Hz Overall accuracy @25°C (= $?_L + I_{OE}$)	acc?	ppm	-7		7
AC Maximum gain error 10Hz to 2kHz	$?_G$	%			±0.01
Operating temperature range	T_a	°C	-40		65
Power supply voltages	U_c	V	±14.25		±15.75

All ppm (or %) values refer to nominal current

Electrical specifications at Ta=23°C, supply voltage = ± 15V unless otherwise stated

Parameter	Symbol	Unit	Min	Typ.	Max	Comment
Nominal primary AC current	$I_{PN AC}$	Arms			2000	Refer to fig. 1 & 2 for derating
Nominal primary DC current	$I_{PN DC}$	A	-3000		3000	Refer to fig. 1 for derating
Measuring range	I_{PM}	A	-3000		3000	Refer to fig. 1 & 2 for derating
Overload capacity	\hat{I}_{OL}	kA			10	Non-measured, 100ms
Nominal secondary current	I_{SN}	mA	-2000		2000	At nominal primary DC current
Primary / secondary ratio			1:1500		1:1500	
Measuring resistance	R_M	Ω	0		3	Refer to fig. 1 for details
Linearity error	ϵ_L	ppm μA	-1 -2		1 2	ppm refers to nominal current μA refers to secondary current
Offset current	I_{OE}	ppm μA	-6 -12		6 12	ppm refers to nominal current μA refers to secondary current
DC-10Hz Overall accuracy @25°C (= ϵ_L + IOE)	acc ϵ	ppm	-7		7	ppm refers to nominal DC current
Offset temperature coefficient	TC_{IOE}	ppm/K $\mu A/K$	-0.1 -0.2		0.1 0.2	ppm refers to nominal current μA refers to secondary current
Bandwidth	$f(-3dB)$	kHz	300			Small signal, graphs figure 3
Amplitude error	ϵ_G	%			10Hz -2kHz	0.01%
2kHz -10kHz					1.50%	
10kHz - 100kHz					3.00%	
Phase shift	θ	°			10Hz -2kHz	0.04°
2kHz -10kHz					0.5°	
10kHz - 100kHz					3°	
Response time to a step current IPN	$tr @ 90\%$	μs		1		di/dt = 100A/ μs
Noise	noise	ppm rms			0 - 100Hz	0.02
0 - 1kHz					0.10	
0 - 10kHz					1.20	
0 - 100kHz					3.50	
Fluxgate excitation frequency	f_{Exc}	kHz		15.6		
Induced rms voltage on primary conductor		μV rms			5	
Power supply voltages	U_c	V	±14.25		±15.75	
Positive current consumption	I_{ps}	mA	160	170	185	Add I_s (if I_s is positive)
Negative current consumption	I_{ns}	mA	150	160	170	Add I_s (if I_s is negative)
Operating temperature range	T_a	°C	-40		65	
Stability						
Offset stability over time		ppm/mon $\mu A/month$	-0.1 -0.2		0.1 0.2	ppm refers to nominal current μA refers to secondary current
Offset change with vertical external magnetic field		$\mu A/mT$		0.2	0.8	(perpendicular to bus bar) μA refers to secondary current
Offset change with horizontal external magnetic field		$\mu A/mT$		0.8	2	(parallel to bus bar) μA refers to secondary current
Offset change with power supply voltage changes		$\mu A/V$		0	0.04	μA refers to secondary current
Offset change with absolute power supply voltages tracking		$\mu A/V$		0.01	0.04	μA refers to secondary current

Maximum measurement resistor vs. ambient temperatures

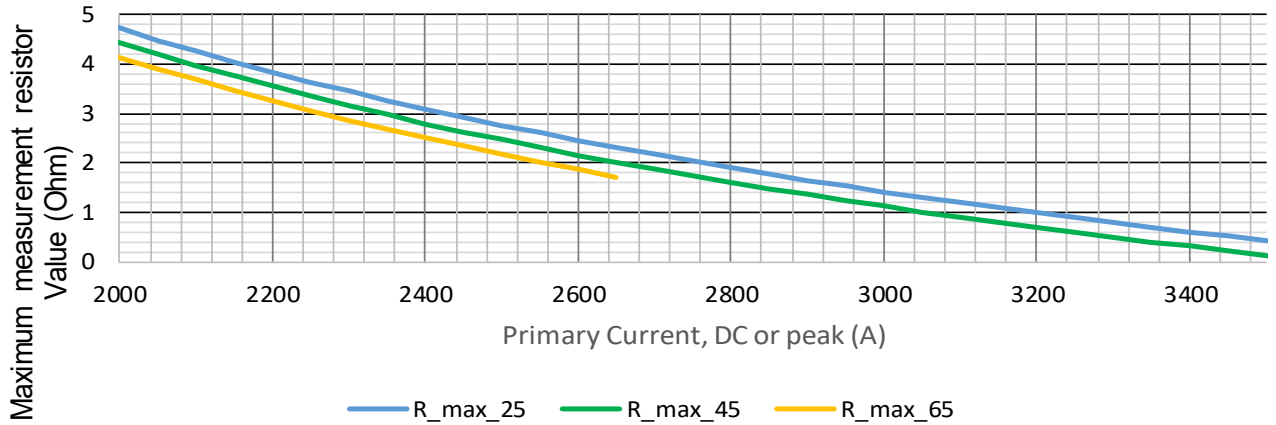

Frequency and ambient temperature derating (Fig. 2)

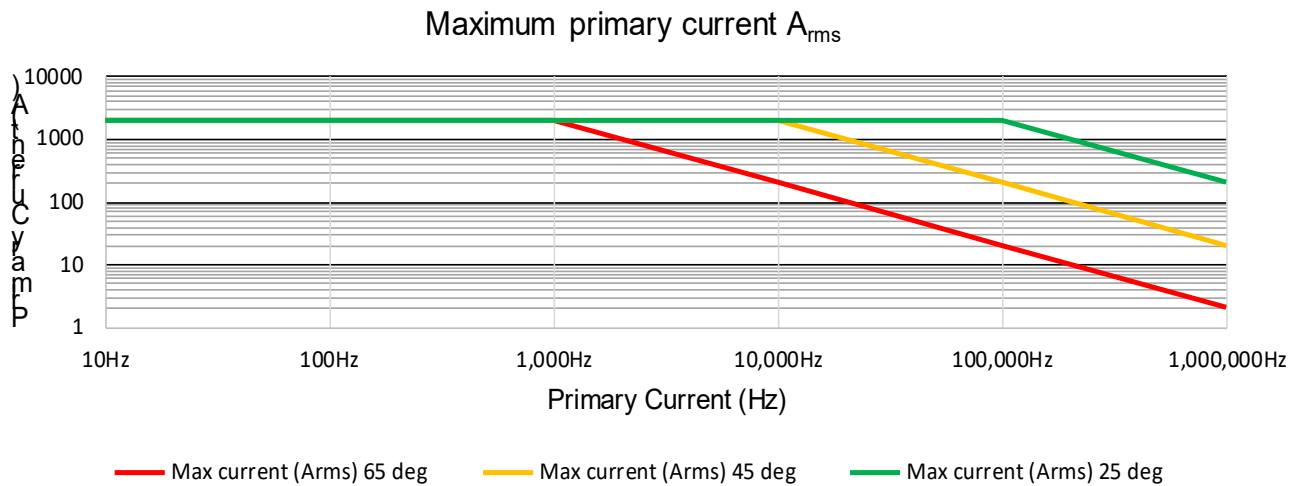

Frequency characteristics (Fig. 3)

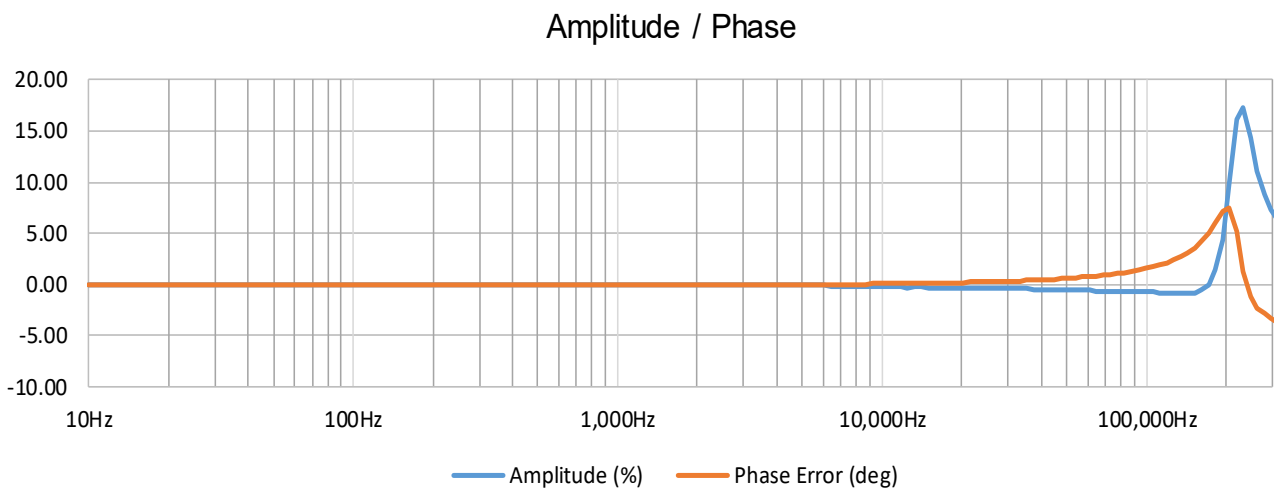

Isolation specifications

Parameter	Unit	Value
Clearance	mm	22
Creepage distance	mm	22
Comparative tracking index (CTI)	V	> 600
Rms voltage for AC isolation test, 50/60 Hz, 1 min - Between primary and (secondary and shield) - Between secondary and shield	kV	14.4 0.2
Impulse withstand voltage (1.2/50µs)	kV	26.3
Rated rms isolation voltage reinforced isolation, overvoltage category III, Pollution degree 2 according to - IEC 61010-1 - EN50780	V	1500 1500

Absolute maximum ratings

Parameter	Unit	Max	Comment
Primary	kA	10	Maximum 100ms
Power supply	V	±16.5	
Maximum calibration current	mA	500	Continuous - with no primary current present
Calibration winding resistance	Ω	7	

Environmental and mechanical characteristics

Parameter	Unit	Min	Typ	Max	Comment
Ambient operating temperature range	°C	-40		65	
Storage temperature range	°C	-40		65	
Relative humidity	%	20		80	Non-condensing
Mass	kg		6.5		
Connections	Power supplies: D-SUB 9 pins male				
Standards	EN 61326-1 EMC EN 61010-1:2010 Safety				

Advanced Sensor Protection Circuits “ASPC”

Developed to protect the current transducer from typical fault conditions:

- Unit is un-powered and secondary circuit is open or closed
- Unit is powered and secondary circuit is open or interrupted

Both DC and AC primary current up to 100% of nominal value can be applied to the current transducers in the above situations without damage to the electronics.

Please notice that the sensor core can be magnetized in all above cases, leading to a small change in output offset current (less than 10ppm)

Status pins

When transducer is operating in normal condition, the status pins (3 and 8) are shorted.

Status pins properties: - forward direction pin 8 to pin 3, maximum forward current 10mA
- maximum forward voltage 60V, maximum reverse voltage 5V

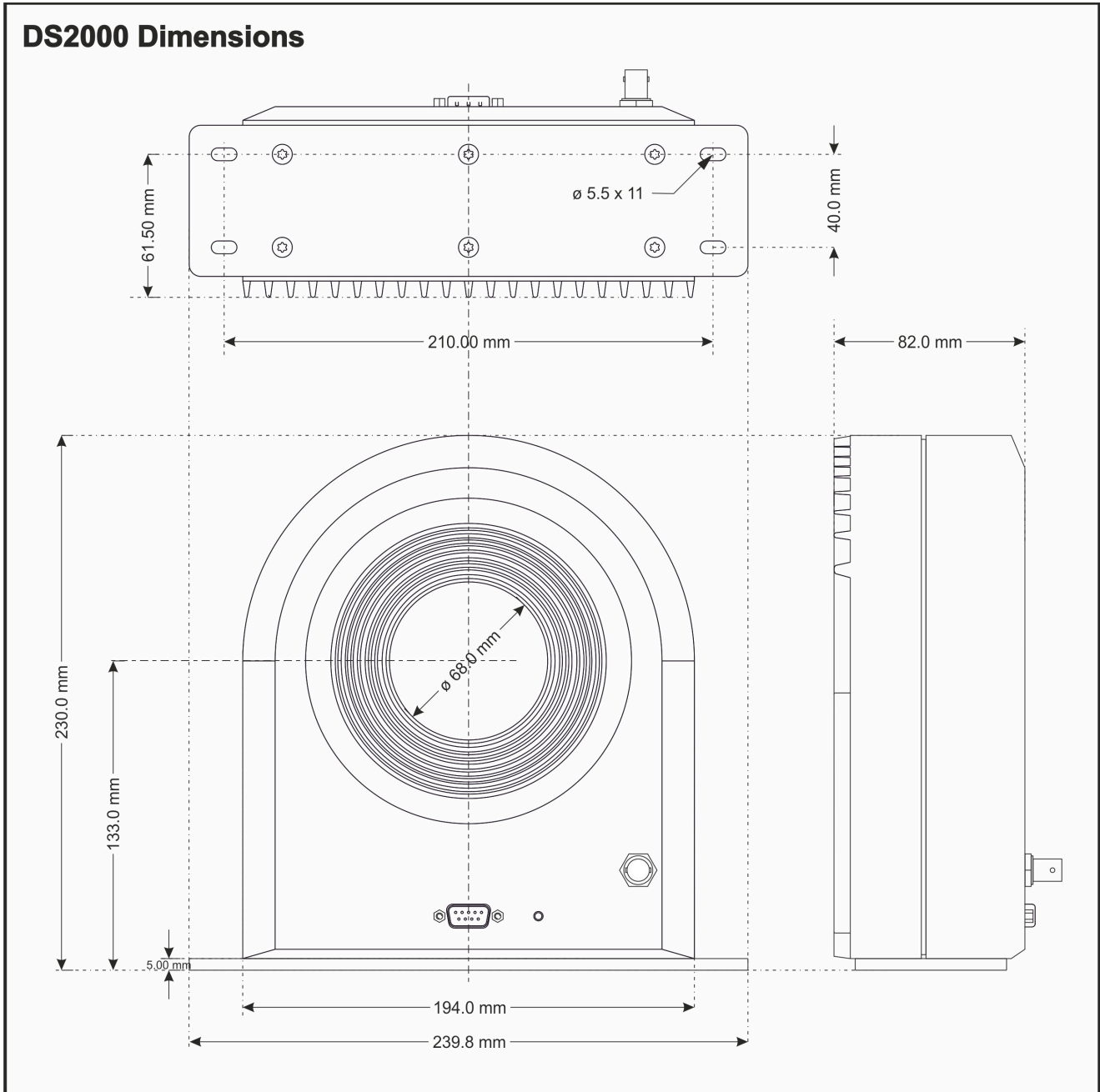

Standard DSUB-9 current output

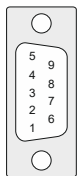

When sensor is operating in normal condition the status pins are shorted.

- Status pin properties.
- Forward direction pin 8 to pin 3
 - Maximum forward current 10mA
 - Maximum forward voltage 60V
 - Maximum reverse voltage 5V

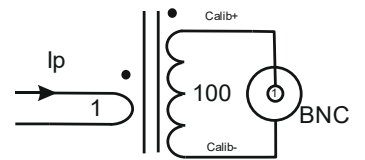
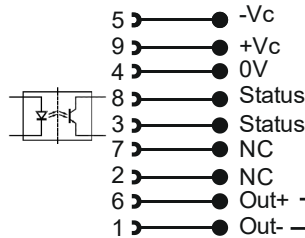

Positive current direction

Is identified by an arrow on the transducer body

Mounting instructions

- Base plate mounting
 - 4 holes $\phi 5.5 \times 11$
 - 4 x M5 steel screws / 6N.m

Declaration of Conformity

Danisense A/S
Malervej 10
DK-2630 Taastrup
Denmark

Declares that under our sole responsibility the products listed in Appendix A are in conformity with the provisions of the following EC Directives, including all amendments, and with national legislation implementing these

directives:

Directive 2014/30/EU

Directive 2014/35/EU

And that the following harmonized standards have been applied

EN 61010-1 (Third Edition):2010, EN 61010-1:2010

EN 61010-2-030:2010

EN 61326-1:2013

All DANISENSE products are manufactured in accordance with RoHS directive 2011/65/EU. Annex II of the RoHS directive was amended by directive 2015/863 in force since 2015, expanding the list of 6 restricted substances (Lead, Hexavalent Chromium, PBB, PBDE and Cadmium)

Danisense follows the provision in EN 63000:2018

Appendix A describes the products covered by this Declaration of Conformity.



Place

Taastrup, Denmark

Henrik Elbæk

Date

2022-03-15